

< Industrial flame control equipment >

FLAME DETECTION SINGLE/DOUBLE ELECTRODE UV cell
DOUBLE GAS SOLENOID + FAN



SAITEK srl

www.saitek.it info@saitek.it

Casalgrande (RE) ITALY - Tel. +39 0522 848211 Fax +39 0522 849070



ATTENTION!

If assembly, adjustment, modification, use or maintenance they are not performed correctly, they can occur injury or damage.

Please read the instructions first to use the product to come installed according to regulations in force in the countries of installation.

Label example

		SAITEK srl Via IV Novembre 4 - 42013 CASALGRANDE (RE) ITALY	
mod. www.saitek.it			
CF6 - P001		ATTENZIONE PRIMA DELL'USO LEGGERE IL MANUALE DI ISTRUZIONI ATENCION ANTES DE USAR LEA EL MANUAL DE INSTRUCCIONES CAUTION BEFORE USE READ THE INSTRUCTION MANUAL ATTENTION AVANT UTILISATION LISEZ LE MANUEL INSTRUCTION LO 2023 10	
spec. According to EN 298			
V ~ 230	Wt T 5 sec		
HZ 50/60	Ig T 5 sec		
W 15	Ig ED 100%		
IP 40	Sc T 1 sec		
°C 0/+60	Sens. 1,2 µA		
	Ev2 T 5 sec		
s/n ??????????			
ATTENZIONE!!!! SCOLLEGARE L'ALIMENTAZIONE PRIMA DI APRIRE IL COPERCHIO			
		WARNING!!!! DISCONNECT POWER SUPPLY BEFORE OPEN THE COVER	

Label encoding



USE INSTRUCTIONS

Read carefully and preserve this use and maintenance reference manual.

ATTENTION!!!

Any indication and operation indicated in the present manual shall be carried out only by authorized and qualified personnel in charge.

Improper and incorrect assembly, adjustment, modification, use or maintenance can cause serious damages and accidents to persons and things.

Read carefully the instructions before installing the appliance. The assembly shall be in compliance with the regulations in force.

In order to prevent accidental electrocutions it is recommended you disconnect the electric current before opening the appliance.

Before supplying power check the value reported on the tag.

CONFORMITA'

The manufacturer declares:

- The **CF6** has been designed, realized and tested in compliance with the European Rule EN298 relative to "Control and safety automatic systems for gas burners and gas appliances with or without fan.
- The **CF6** it also complies with the requirements essential provisions set out in the following Directives:
 - 22006/42 together with the paragraphs relevant of EN 746,
 - 22014/35/EU together with the regulations relevant
 - 22014/30/EU together with the regulations relevant information relating to disturbances electromagnetic
- This device shall be integrated with a valve-proving system according to EN 1643:2022

that checking the leakage during each burner cycle

- EMC emission requirements shall be tested after the incorporation into the equipment

APPLICATIONS

The **CF6** flame control appliance directly lights and controls intermittent gas burners, **or rather burners that shall be turned off at least once in the 24 hours.** The burner is checked by an ionization electrode.

For grounded grids.

With a single restart due to flame put out.

The **CF6** can be applied directly to the burner in industrial thermal processes for metals, glass, ceramic, plastic, chemical, etc...., where there is no need of a pre-ventilation before turning it on.

Besides it can be applied on atmospheric burners for general heating.

ATTENTION

Avoid presence of condensation inside the box and on the card surface.

TECHNICAL SPECIFICATIONS

- For data relative to power supply specifications (V ≈/Hz/W), working temperature (°C), IP protection class, waiting time before starting (Wt), discharge times (I_g T), safety (Sc) and threshold of detection (Sens.) refer to the tag.
- The load tension shall be the same of the power supply.
- **Double spark plug detection by electrodes, if request mono electrode or UV lamp**
- Possibility of using ignition transformers both electronic and standard wound.
- LED display: on, block, ignition and flame detection, EV2 GAS, Fan.
- Alarm contact in exchange: NC closed when blocked, NA closed when in detection.

DISPLAY CARD

The flame control **CF6** can be provided together with an additional view tab (optional). This offers the opportunity of being able to control the functionality of the apparatus in a more effective and immediate. This is made possible by the four LEDs for displaying the level of the flame, the LED control of the authorization of security systems and the control LED unlocking remotely. The latter also remains slightly on when the switch is in position 0 to indicate voltage presence (NB used only by authorized personnel keeping under strict control the burner to ignite).

MOUNTING

- Mounting position as desired
- Installation of the fixed back side with 4 holes preformed to remove pressure.

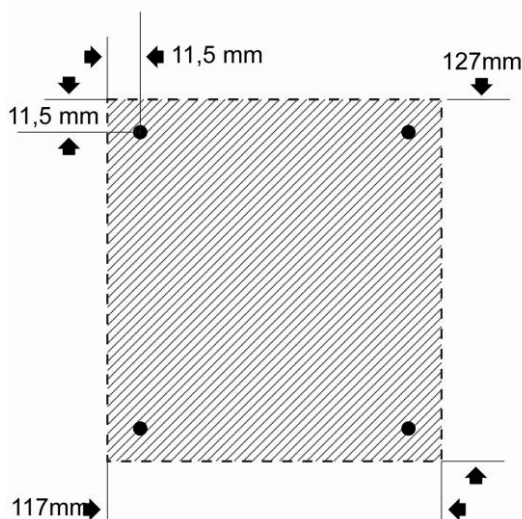

- Dimensions 117x127x122
 - Prepared to pipe fixing collars
- CF6** is normally provided already wired, otherwise perform the necessary holes only in the back and use cable guides which ensure at least the same degree of IP protection (40).

RECCOMEND CABLES

- IONIZATION: max. length 10 m. with section 1 mm. Place far from interference sources , avoid external electric influences.
- IGNITION: **like from specific of the constructor of the ignition transformer.** Suggested conductor diameter 1 mm. Place singularly far from metal parts

WIRING

Disconnect the plant.

In three-phase plants use the same phase on the inputs. No power shall be present on the solenoid valve outlet.

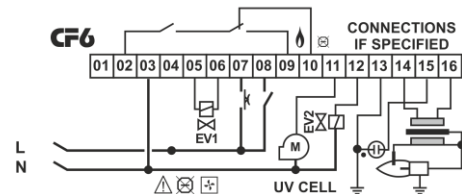
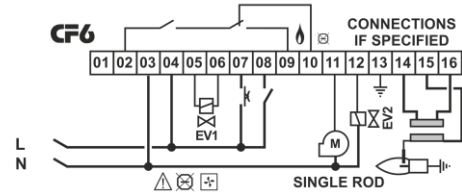
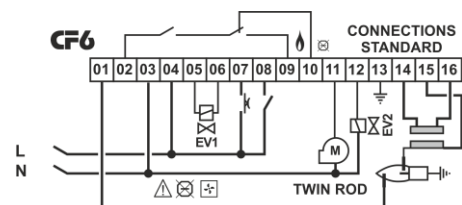

The **CF6** enabling control deriving from the safety sequence (main controls device for safety such as thermostats, GAS min., Gas max., seal control, pre-washing, etc....) shall be contacts without tension.

Do not invert phase and neutral wire.

The outlet power for the solenoid valve and the ignition transformer (usually included in **CF6**) and the inlet power are the same.

The max. current of solenoid valve and ignition transformer is 1A.

Alarm contact max 1A 230 Vac **not protected by inner fuse.**

For a correct operating, carry out a good earth connection of the **CF6** to the burner ground.

COMMISSIONING

1. Open the gas valve.
2. Start the installation.
3. Switch on the **CF6**.
4. Press the power button (power green LED lights).
5. Immediately output is enabled for the supply of combustion air fan.
6. Supply power to control release to start the ignition cycle.
7. The waiting time at the start (or pre-wash) is indicated on the label.
8. After this time the **CF6** perform the ignition cycle. The gas solenoid will be driven and at the same time the ignition discharge is made (ignition yellow LED lights). At the end of the discharge the presence of the flame will be controlled.
9. In flame presence the equipment goes into operating mode by turning on the detection green LED and continuing to feed the main gas valve solenoid , after the time stated on the label, will be enabled output to power the second gas valve solenoid.
10. If otherwise **CF6** will go in lock state will be removed power: to the gas valve, to the combustion air fan, closes the alarm contact and the block state red LED will lights. To reset and retry the cycle it will move OFF and move ON again the main power switch..

N.B. The terminal  must never be used. This terminal has capabilities unlock remotely and must be used by authorized personnel only with strict monitoring of the burner to rekindle.

OPERATION CHECK

1. During the operating remove the detection pipe
2. The **CF6** will try to restart only one time, then it will block because of an anomaly (the solenoid valve power will be cut off, the alarm contact will close and the red LED will light).
3. The burner flame shall die down.
4. In case of different operation, check the wirings and if the problem is not solved disassemble **CF6** and send it to the manufacturer for a complete overhauling.

After the replacement of the safety device, check its operation:

- Turn off the main gas valve and check that the appliance does not start.

If the safety device works correctly and the wiring is in good order but the appliance starts the burner, send it to the manufacturer for an inspection.

Wt => Waiting Time – Prepurge or waiting time start cycle.

It => Ignition Time – ignition time.

G2t => waiting time to power second gas valve solenoid.

OPERATING MODES GRAPHS A

OPERATING MODES GRAPHS B

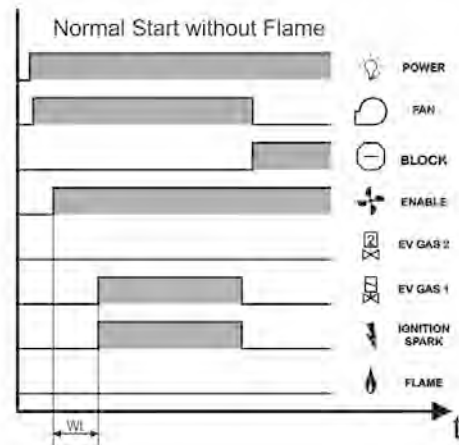
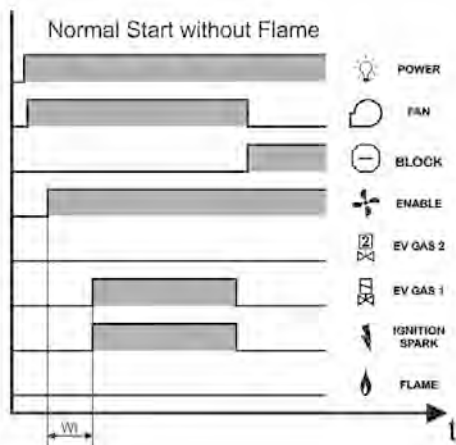
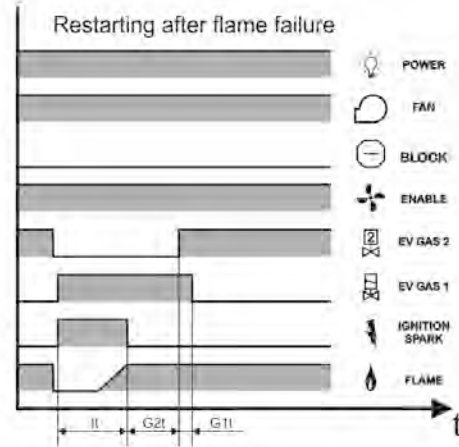
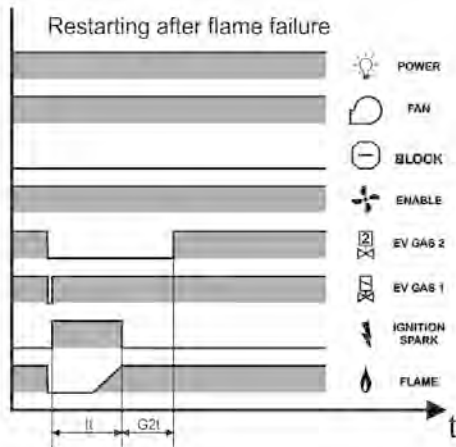
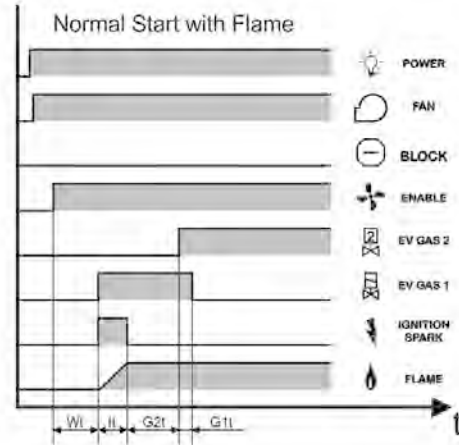
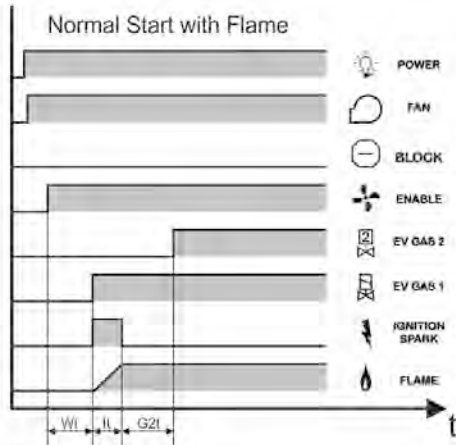



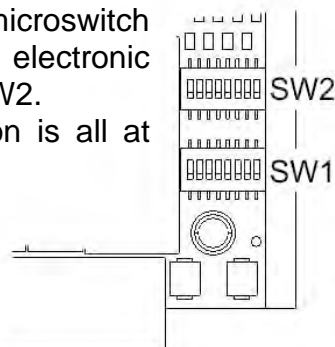



In the **CF6 si** it is possible to set some function and some value through 2 series of 8 microswitch housed on board the electronic card called SW1 and SW2. The basic configuration is all at 0.

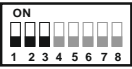
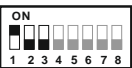
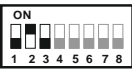

SW1 SETTING

TIME SETTING

Prewash time setting

Prewash Time setting 5 sec	
Prewash Time setting 1 sec	
Prewash Time setting 8 sec	
Prewash Time setting 10 sec	
Prewash Time setting 20 sec	
Prewash Time setting 30 sec	
Prewash Time setting 50 sec	
Prewash Time setting 70 sec	

Ignition time

5 sec		12 sec	
-------	---	--------	---

Flame failure safety time

2 sec		3 sec	
-------	---	-------	---

FUNCTION SETTING

Re-ignition attempt due to flame failure

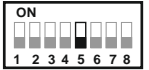
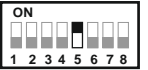
SI		NO	
----	--	----	---

No. of ignition/re-ignition attempts

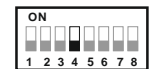
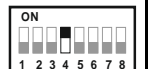

N° 1		N° 3	
------	--	------	---

Continuous service self-test

Activated		Deactivated	
-----------	--	-------------	---

SW2 SETTING

EV2 gas ON time

3,5 sec		10 sec	
---------	--	--------	---

EV1 gas OFF after EV2 gas

NO		SI	
----	--	----	---

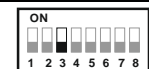
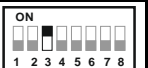

EV1 gas time OFF

3,5 sec		10 sec	
---------	--	--------	---

Post Ventilation

YES		NO	
-----	--	----	---

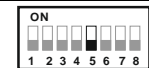
Post Ventilation Time

3,5 sec		10 sec	
---------	--	--------	---

Fan Start Command

At ignition		External Enable	
-------------	--	-----------------	---

OPERATION DISPLAY



OFF
+ Power Supply

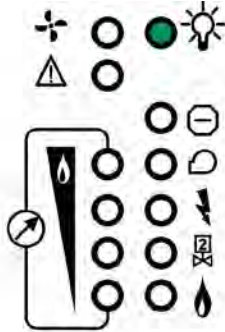

Power ON

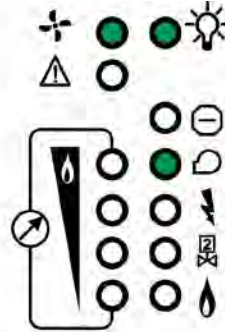

Enabled
+ Combustion
Air Blower



Ignition

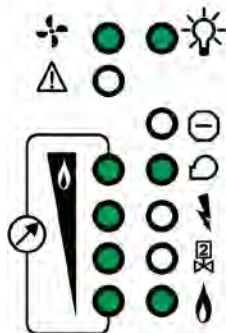

Flame Detect
Flame Signal
Ev1 Gas



Flame Detect
Flame Signal
Ev1 Gas
Ev2 Gas

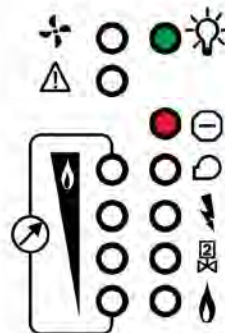

Burner
Block Mode
Flame Loss



Remote
Unlock
Pulse

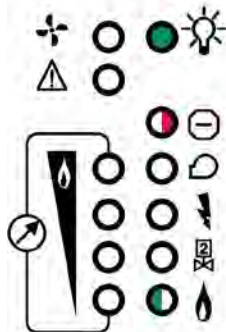

Illegal Flame
Detect Block

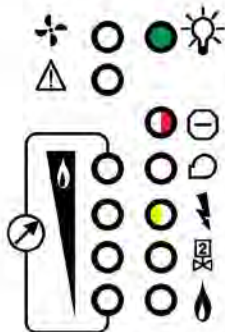

HT Transformer
Not Connected
Block



Ev1 Gas
Not Connected
Block



Internal
Loads Security
Damaged

RECTIFICATION OF FAULTS

CAUTION!!!

Danger of death due to shocks!
Before intervening on the appliance cut off the tension to any cable.

The elimination of breakdowns can be carried out by authorized personnel only.

In case of improper repairs or incorrect electrical connections, the good running of the appliance is not granted.

The release at distance can be carried out only by authorized personnel keeping under strict control the burner to be lighted

? < TROUBLE >
! < CAUSE >
* < REMEDY >

? THE IGNITION SPARK DOES NOT APPEAR.

! The distance between the electrode and the burner body is too great.

* Set a distance of max. 2 mm.

! The igniter cable does not make contact with the pipe.

* re-screw the pipe tightly.

! The igniter cable has a leakage on the earth.

* Check the laying of the cable, clean the ignition electrode.

! The ignition voltage is too low.

* use an ignition transformer with power > 5 KV

! The ignition cable is too long.

* Shorten its length to 1 m. (max. 5 m.)

! The igniter cable does not make contact.

* Screw it tightly on the ignition transformer.

? THE GAS DOES NOT REACH IT

! The gas solenoid valve does not open

* Check the solenoid valve connection.

! There is still presence of air in the gas hosepipe.

* Make many ignition attempts in order to fill completely the gas hosepipe.

? THE GAS DOES NOT REACH IT AND THE IGNITION SPARK DOES NOT APPEAR, THE CF6 DOES NOT START.

! Short circuit in the ignition or in the solenoid valve outlet.

* Check the wiring

- in case of short circuit in outlets eliminate it and change the inner fuse (2,5 A). Or send the appliance to the manufacturer.

? THERE IS THE FLAME BUT THE DETECTION LED IS OFF.

! The detection electrode is in short circuit because of dirt, soot or damp.

! The detection electrode is not in a correct position as to the flame.

! The combustion air/gas ratio is incorrect.

! The flame makes no contact with the burner body because air and/or gas pressure is too high.

! The burner or CF6 are not earthed correctly.

! Short circuit or detection cable interruption.

! Phase and neutral wire inverted.

* Eliminate the defect.

? THE APPLIANCE DOES NOT PERFORM THE IGNITION CYCLE AND GOES IMMEDIATELY IN DETECTION.

! Anomaly on the detection (flame simulation)

* Eliminate the cause of the flame anomaly.

! Anomaly of the flame detection circuit.

* Send the appliance to the manufacturer for its replacement.

? THE APPLIANCE DOES NOT START EVEN IF ALL THE TROUBLES HAVE BEEN ELIMINATED AND THE MAIN SWITCH HAS BEEN PRESSED.

* Send the appliance to the manufacturer for the functional inspection.

WARRANTY

The devices are guaranteed free from defects of manufacture for 12 months from installation with a maximum of 18 months from delivery. Defects caused by use other than that described herein are excluded from the guarantee. See the instructions for use and applications.

SAITEK srl

Via IV Novembre n° 4
42013 Casalgrande (RE) - ITALY
<http://www.saitek.it> e-mail info@saitek.it
Tel. 0522.848211 fax 0522.849070